

Updated and Revised - 2013

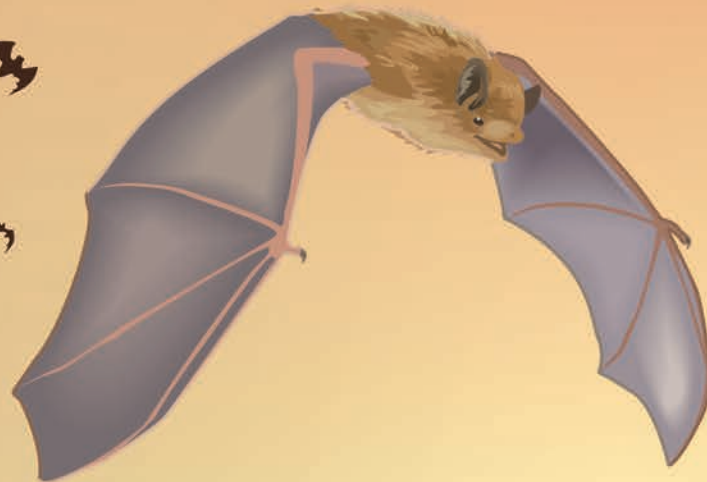

# The Bat House Builder's H a n d b o o k

Merlin D. Tuttle  
Mark Kiser  
Selena Kiser



batcon.org  
**BAT CONSERVATION**  
INTERNATIONAL



# Four-chamber Nursery House

**Materials (makes two houses) • Diagrams on pages 12 & 13**  
 ½ sheet (4' x 4') ½" AC, BC or T1-11 (outdoor grade) plywood  
 ½ sheet (4' x 4') ¾" AC or BC (outdoor grade) plywood  
 Two pieces 1" x 6" (¾" x 5½" finished) x 8' pine or cedar  
 One lb. coated deck or exterior-grade screws, 1½"  
 20 to 25 coated deck or exterior-grade screws, 1¼"  
 20 to 25 exterior-grade screws, 1"  
 One quart dark, water-based stain, exterior grade  
 One quart water-based primer, exterior grade  
 Two quarts flat water-based paint or stain, exterior grade  
 One tube paintable latex caulk  
 Black asphalt shingles or galvanized metal  
 12 to 20 roofing nails, ¾"

## Recommended tools

Table saw or circular saw	Paintbrushes
Variable-speed reversing drill	Hammer (optional)
Screwdriver bit for drill	Tin snips (optional)
Tape measure or yardstick	Bar clamp (optional)
Caulking gun	Sander (optional)

## Construction

1. Measure, mark and cut out all wood according to the sawing diagrams on pages 12 and 13.
2. Roughen interior and landing surfaces by cutting horizontal grooves with sharp object or saw. Space grooves ¼" to ½" apart, cutting ½" to ⅙" deep.
3. Apply two coats of dark, water-based stain to interior surfaces. Do not use paint unless the grooves are quite deep.
4. Attach side pieces to back, caulking first. Use 1½" screws. Make sure top angles match.
5. Attach 5" and 10" spacers to inside corners per drawings on page 12. Use 1" screws. Roost-chamber spacing will be ¾" (front to back). Do not block side vents.
6. Place first roosting partition on spacers even with bottom edge of roof. Place 20" spacers on partition and screw to first spacers (through partition), using 1½" screws.
7. Repeat step 6 for remaining spacers and partitions.
8. Attach front to sides, top piece first (caulk seams). Be sure top angles match (sand if necessary). Leave ½" vent space between top and bottom front pieces. A bar clamp may be useful if sides have flared out during construction.
9. Attach roof supports to the top inside of front and back pieces with 1" screws. Don't let screws protrude into roosting chambers.
10. Caulk around all top surfaces, sanding first if necessary to ensure good fit with roof.
11. Attach roof to sides and roof supports with 1¼" screws. Caulk around roof and side joints to further guard against leaks and drafts. Don't let screws protrude into roosting chambers.
12. Paint or stain exterior three times (use primer for first coat).
13. Cover roof with shingles or galvanized metal.

## Optional modifications

1. These nursery-house dimensions were chosen to permit construction of two bat houses per half-sheet of plywood. Increasing house width to 24" or more or adding partitions benefits bats and attracts larger colonies. Additional spacers are required to prevent warping of roost partitions for houses more than 24" wide.
2. Taller bat houses provide improved temperature gradients and may be especially useful in climates where daily temperatures fluctuate widely. Bat houses 3' or taller should have the horizontal vent slot 12" from the bottom of the roosting chambers.
3. Two bat houses can be placed back-to-back mounted on poles. Before assembly, a horizontal ¾" slot should be cut in the back of each house about 10" from the bottom edge of the back piece to permit movement of bats between houses. Two pieces of wood, 1" x 4" x 10¾", screwed horizontally to each side, will join the two boxes. Leave a ¾" space between the two houses, and roughen the wood surfaces or cover the back of each with plastic mesh. One 2" x 4" x 40" vertical piece, attached to each side, over the horizontal pieces, blocks light but allows bats and air to enter. Use a 2" x 6" vertical piece if securing houses with U-bolts to metal poles. A galvanized metal roof that covers both houses protects them and helps prevent overheating. Eaves should extend about 3" in front in southern areas and about 1½" in the north.
4. Ventilation may not be necessary in cold climates. In that case, the front of the bat house should be a single, 23"-long piece. Far-northern bat houses may also benefit from a partial bottom to help retain heat. Slope the sides and bottom at an angle of 45° or greater to reduce guano build-up. Leave a ¾" entry gap at the back and be sure the bottom does not interfere with access to the front crevices. A hinged bottom is required to permit annual cleaning.
5. Durable plastic mesh can be substituted for roughening. Attach mesh to backboard, landing area and one side of each partition after staining interior, but prior to assembly. Use only ½-inch HDPE plastic mesh (such as "bat house netting XV1672" from [www.industrialnetting.com/bat\\_houses.html](http://www.industrialnetting.com/bat_houses.html)) and attach every two inches with ⅝" stainless steel staples.
6. Make partitions removable by attaching small cleats with thumbscrews to the bottom of side pieces for support. Spacer strips are unnecessary if grooves for partitions are cut in the side pieces with a router or dado saw blade.

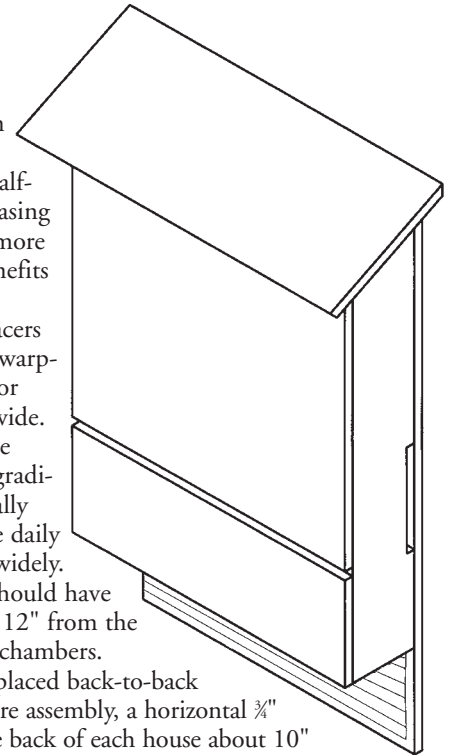
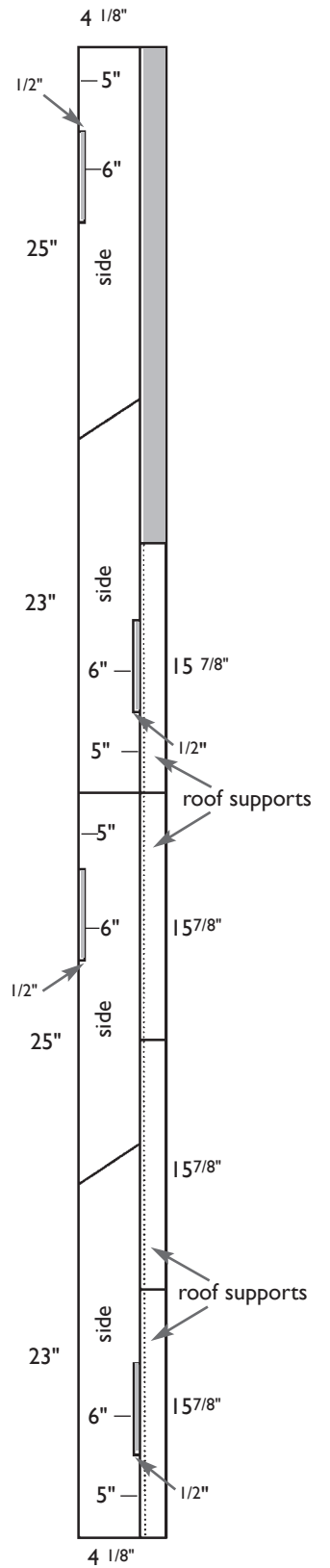
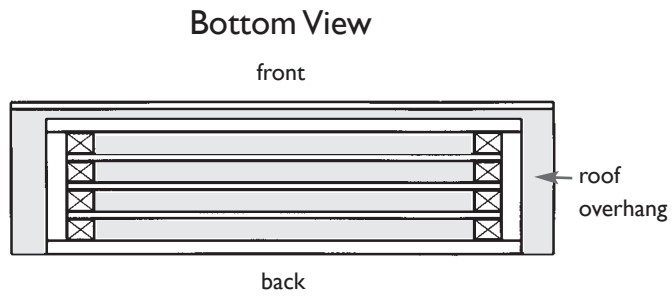
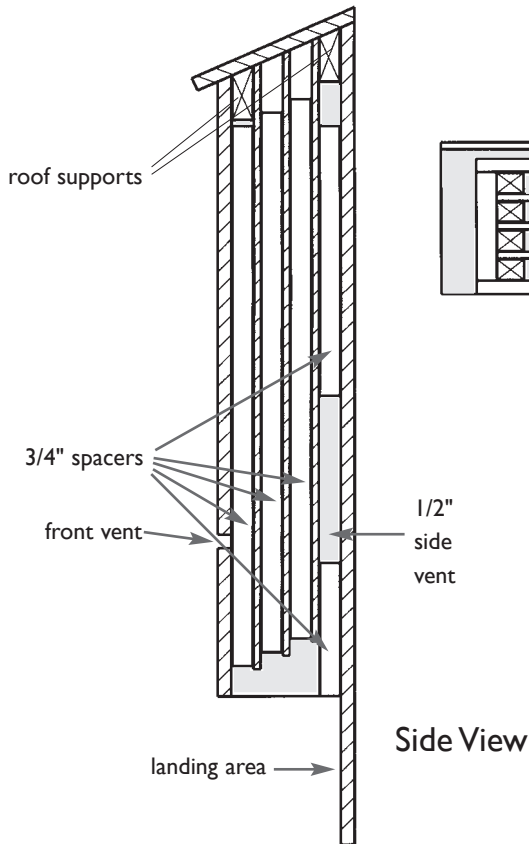
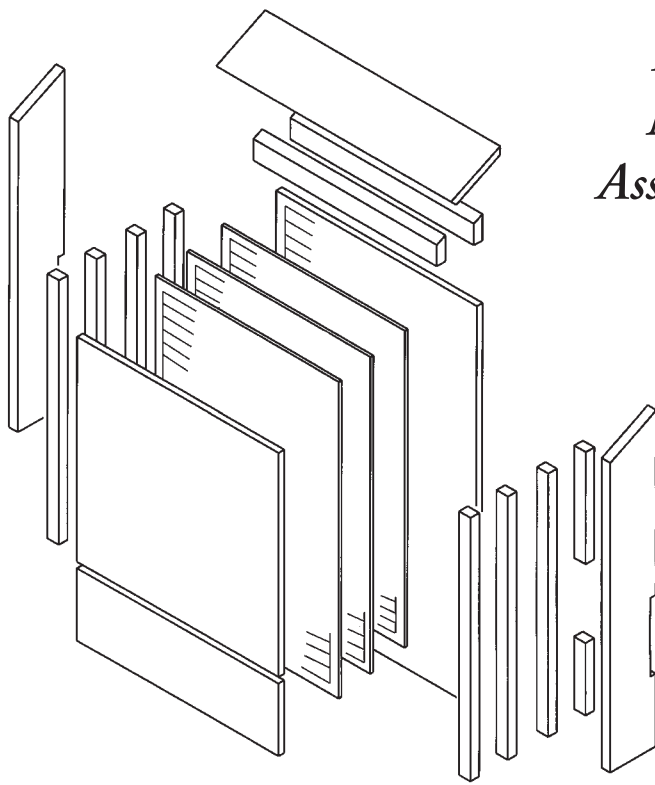

FIGURE 4  
*Four-chamber  
 Nursery House  
 Assembly Diagrams*



1" x 6" x 8' board

FIGURE 5

*Four-chamber  
Nursery House  
Sawing Diagrams*

extra material  
 25 degree bevel

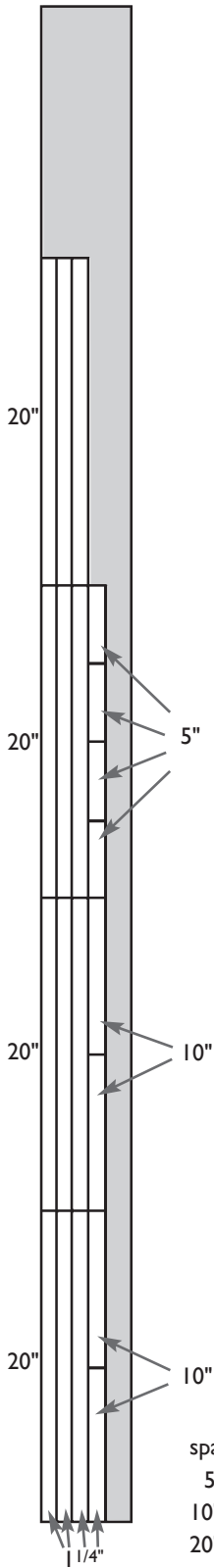

spacers:  
 5" spacers = back bottom  
 10" spacers = back top  
 20" spacers = others

1" x 6" x 8' board

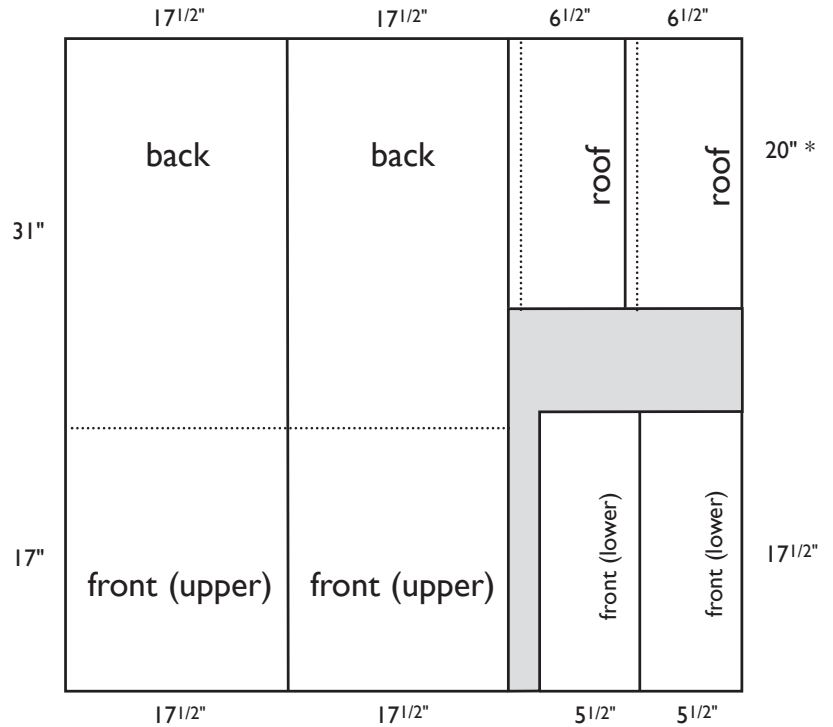

4' x 4' x 1/2" plywood

\* 19" if mounted between two poles

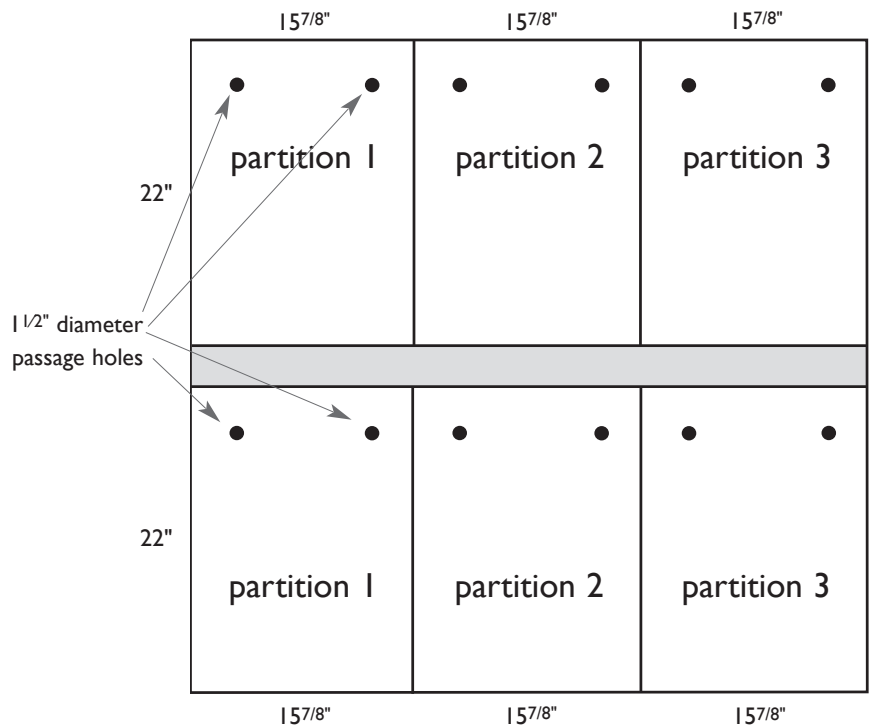

4' x 4' x 3/8" plywood